

Device connector, rear mounting - SACC-DSI-M12MS-4CON-M16 - 1419742

Please be informed that the data shown in this PDF Document is generated from our Online Catalog. Please find the complete data in the user's documentation. Our General Terms of Use for Downloads are valid (<http://phoenixcontact.com/download>)



Sensor/actuator flush-type plug, 4-pos., M12 SPEEDCON, A-coded, rear/screw mounting with M16 thread, with straight solder connection

Your advantages

- ✓ Easy PCB assembly: one-piece connectors for wave soldering
- ✓ All standard pin assignments and codings for signal, data, and power transmission with a uniform design-in design
- ✓ SPEEDCON fast locking system reduces cabling times



Key Commercial Data

Packing unit	1 pc
Minimum order quantity	20 pc
GTIN	 4 046356 533942
GTIN	4046356533942
Weight per Piece (excluding packing)	14.000 g
Custom tariff number	85366990
Country of origin	Germany

Technical data

Dimensions

Length of the solder pin	6 mm
--------------------------	------

Ambient conditions

Ambient temperature (operation)	-25 °C ... 85 °C (Plug / socket)
	-40 °C ... 85 °C (without mechanical actuation)

Device connector, rear mounting - SACC-DSI-M12MS-4CON-M16 - 1419742

Technical data

Ambient conditions

	-25 °C ... 85 °C (Plug / socket)
Degree of protection	IP67 (When plugged in)
	IP65 (When plugged in)

General

Note	The electrical and mechanical data specified assume that the connector pair is correctly locked and mounted. If the connector is unlocked and if there is a danger of contamination, the connector must be sealed using a protective cap > IP54. Influences arising from litz wires, cables or PCB assembly must also be taken into consideration.
Rated current at 40°C	4 A
Rated voltage	250 V
Rated surge voltage	2.5 kV
Number of positions	4
Insulation resistance	≥ 100 MΩ
Coding	A - standard
Standards/regulations	M12 connector IEC 61076-2-101
Status display	No
Overvoltage category	II
Degree of pollution	3
Connection method	Solder pins
Insertion/withdrawal cycles	> 100
Torque	3 Nm ... 4 Nm (Installation-side)
Mounting type	Rear mounting M16 x 1.5 With flat nut
Thread type	M16 x 1.5

Material

Flammability rating according to UL 94	V0
Contact material	CuZn
Contact surface material	Au
Contact carrier material	PA 6.6
Material, knurls	Zinc die-cast, nickel-plated
Sealing material	NBR

Cable

Standards/specifications	M12 connector IEC 61076-2-101
Ambient temperature (operation)	-40 °C ... 85 °C (cable, fixed installation)
	-25 °C ... 85 °C (cable, flexible installation)

Standards and Regulations

Device connector, rear mounting - SACC-DSI-M12MS-4CON-M16 - 1419742

Technical data

Standards and Regulations

Standards/specifications	M12 connector IEC 61076-2-101
Flammability rating according to UL 94	V0

Environmental Product Compliance

REACH SVHC	Lead 7439-92-1
China RoHS	Environmentally Friendly Use Period = 50 years
	For details about hazardous substances go to tab "Downloads", Category "Manufacturer's declaration"

Drawings

Dimensional drawing

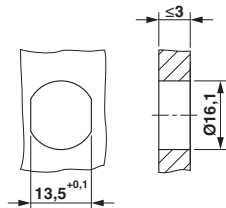

Schematic diagram

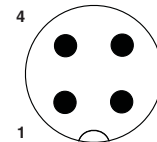

Pin assignment M12 plug, 4-pos., A-coded, view plug side

Housing cutout for M16 fastening thread, mounting panel with feed-through hole (alternatively with area as anti-rotation protection for panel thicknesses > 2 mm up to max. 4.5 mm)

Drilling diagram

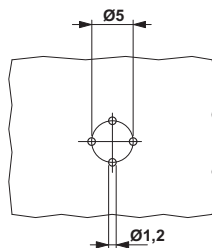

Dimensional drawing

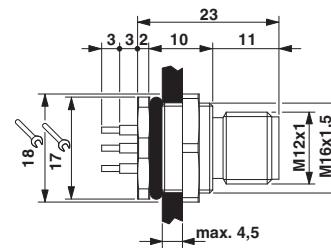

M12 flush-type connector

Device connector, rear mounting - SACC-DSI-M12MS-4CON-M16 - 1419742

Dimensional drawing

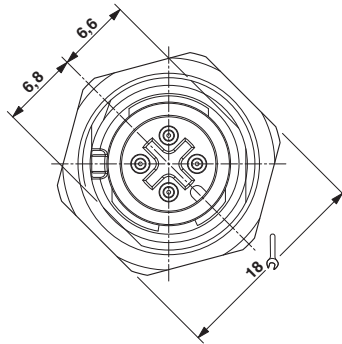

M12 front view

Classifications

eCl@ss

eCl@ss 10.0.1	27440102
eCl@ss 11.0	27440102
eCl@ss 4.0	27140800
eCl@ss 4.1	27140800
eCl@ss 5.0	27143400
eCl@ss 5.1	27143400
eCl@ss 6.0	27279200
eCl@ss 7.0	27440103
eCl@ss 9.0	27440102

ETIM

ETIM 2.0	EC001297
ETIM 3.0	EC002061
ETIM 4.0	EC002061
ETIM 6.0	EC002061

UNSPSC

UNSPSC 6.01	31251501
UNSPSC 7.0901	31251501
UNSPSC 11	31251501
UNSPSC 12.01	31251501
UNSPSC 13.2	39121413
UNSPSC 18.0	39121413

Device connector, rear mounting - SACC-DSI-M12MS-4CON-M16 - 1419742

Classifications

UNSPSC

UNSPSC 19.0	39121413
UNSPSC 20.0	39121413
UNSPSC 21.0	39121413

Approvals

Approvals

Approvals

UL Recognized / EAC / cULus Recognized

Ex Approvals

Approval details

UL Recognized		http://database.ul.com/cgi-bin/XYV/template/LISEXT/1FRAME/index.htm	FILE E 118976
Nominal voltage UN	250 V		
Nominal current IN	4 A		
mm ² /AWG/kcmil	22		

EAC		B.01687
-----	---	---------

cULus Recognized		http://database.ul.com/cgi-bin/XYV/template/LISEXT/1FRAME/index.htm	E221474-20140616
Nominal voltage UN	250 V		
Nominal current IN	4 A		
mm ² /AWG/kcmil	22-20		

Device connector, rear mounting - SACC-DSI-M12MS-4CON-M16 - 1419742

Accessories

Accessories

Protective cap

Sealing cap - PROT-M12 FS - 1560251



M12 sealing cap for unoccupied M12 plugs of the sensor/actuator cable, flush-type plugs and I/O devices in the field

Sealing cap - PROT-M12 FS-M - 1430488



M12 metal sealing cap for unoccupied M12 plugs of the sensor/actuator cable, flush-type plugs and I/O devices in the field

Seal

Flat gasket - SACC-M16-SEAL CLM - 1430394



M16 flat gasket, for rear mounting of M12 flush-type connectors with M16 fastening thread
